

**SINGER**  
**29K71,K72,K73**

ILLUSTRATED  
LIST OF PARTS  
FOR  
CLASS 29K  
MACHINES  
(Nos. 29K71 to 29K73)

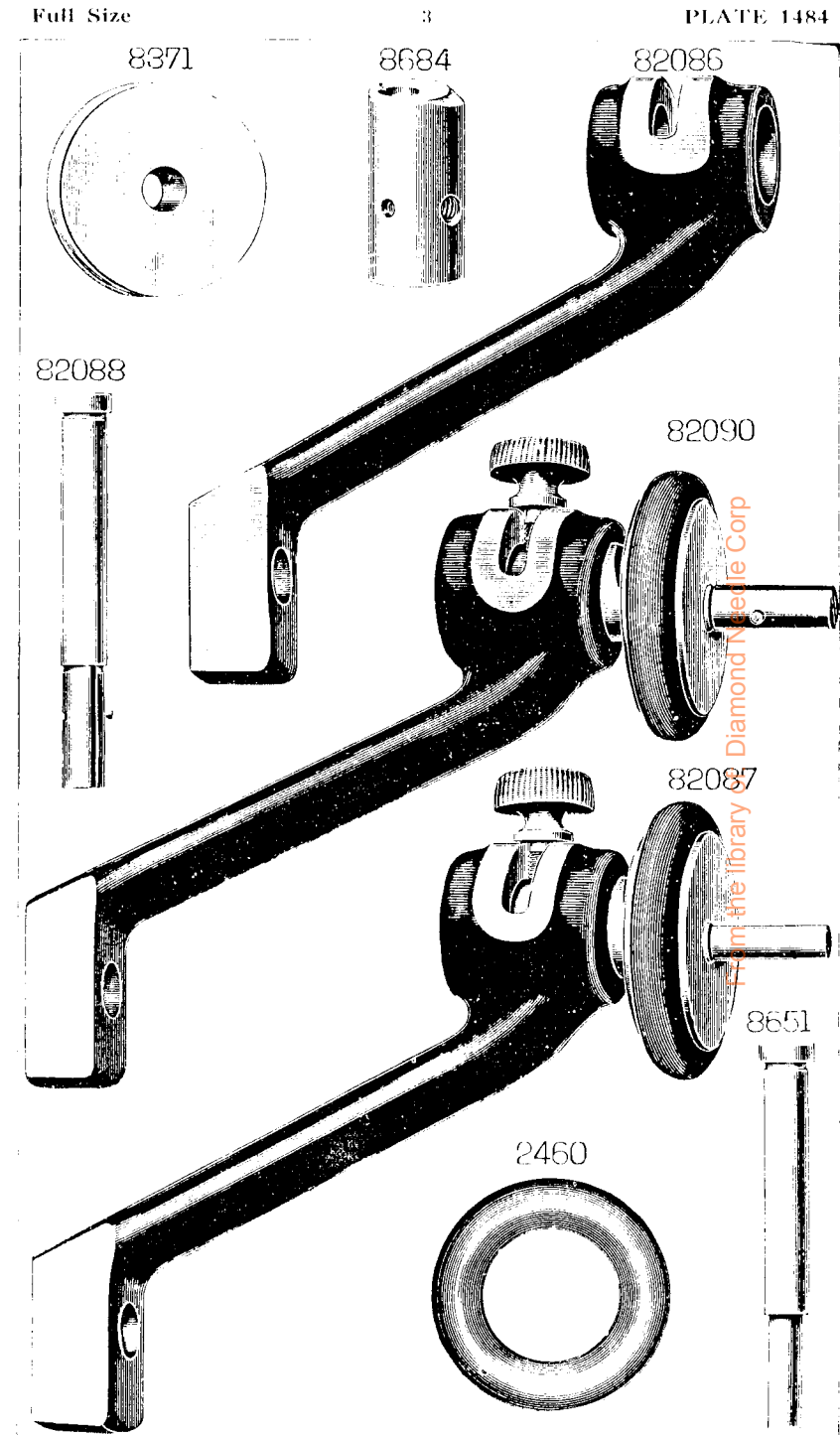

\*\* A Trade Mark of THE SINGER MANUFACTURING CO.



82011 82010

82241

82220

81941

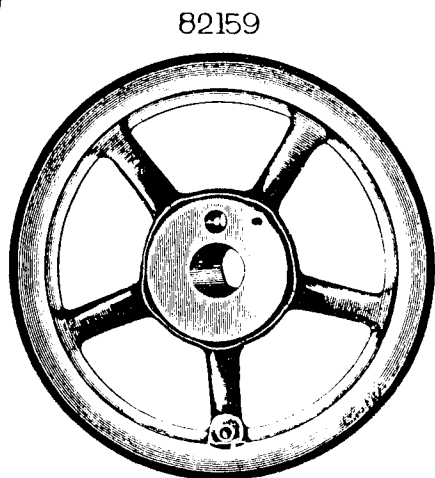
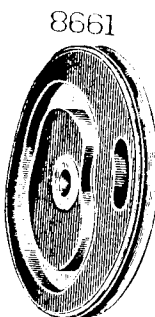
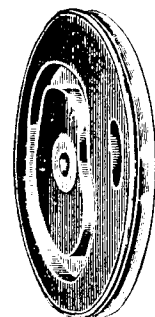
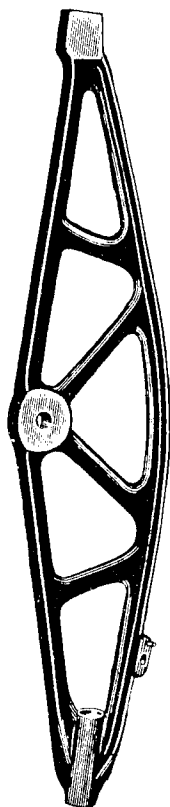
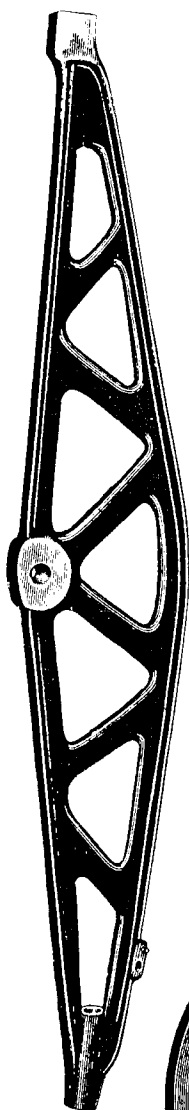

82058

82053

4449

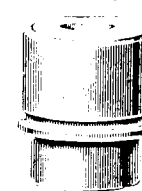
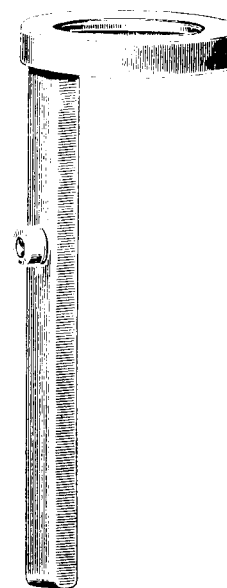
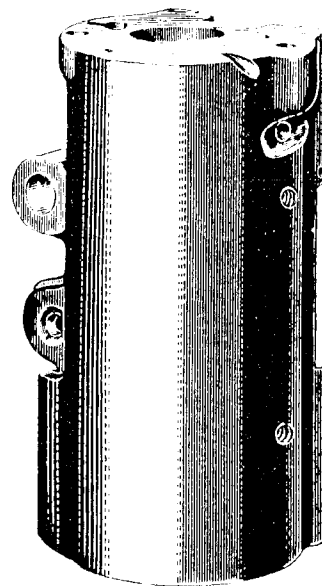

82073



82123

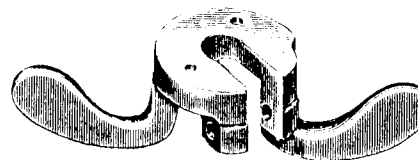

82052

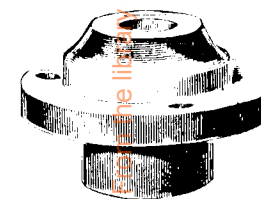

Case file 1132  
Diamond Tool Co.

82030 8675

8573

82129 82130

8590

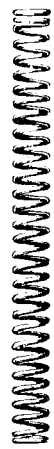
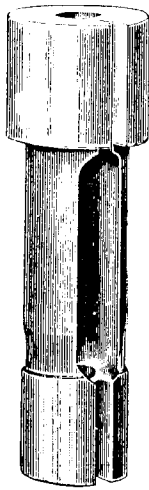

4288

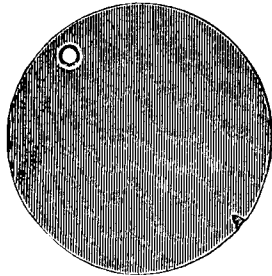

82083



81866



82057

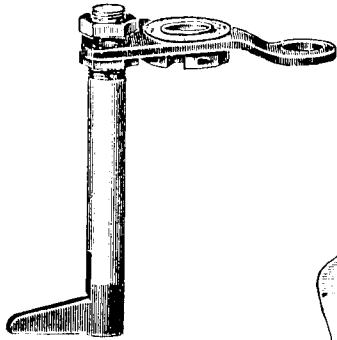

82059



8670

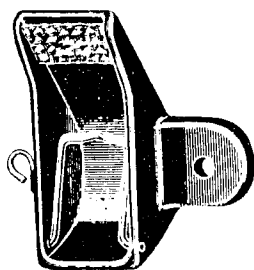

82212

82184

82160

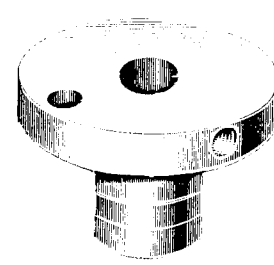
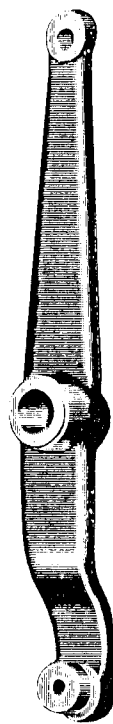

From the library of: Diamond Needle Corp

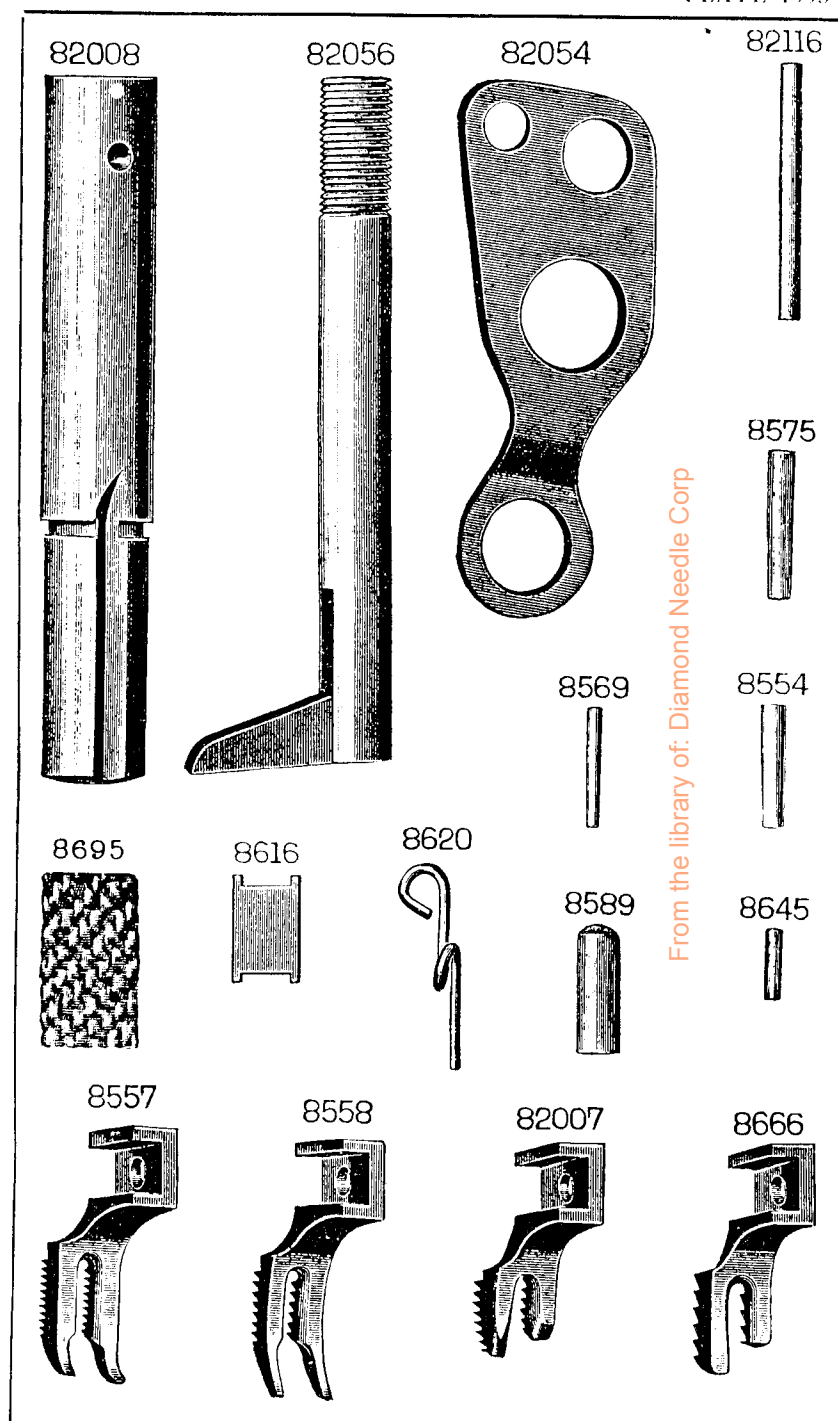
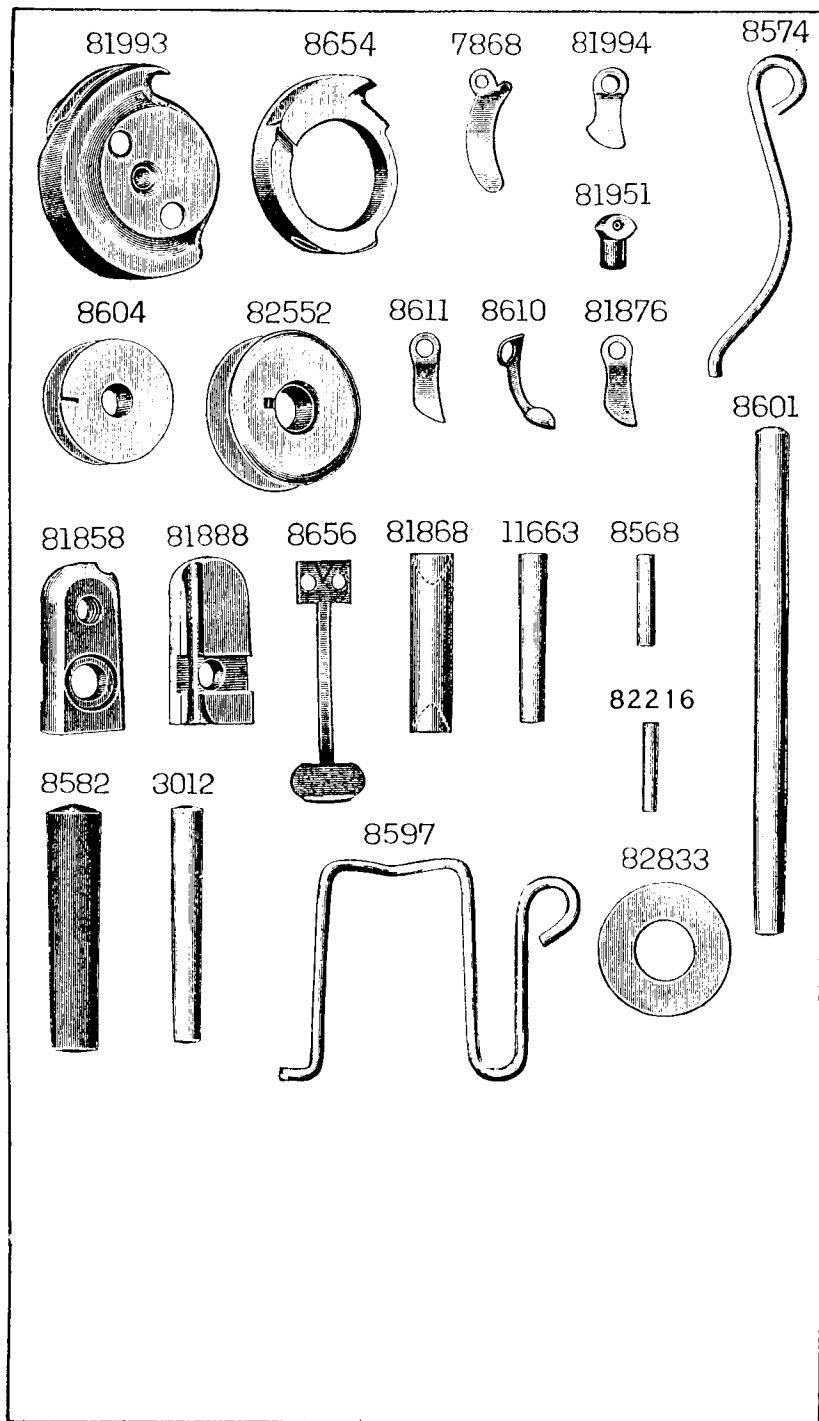

From the library of: Diamond Needle Corp

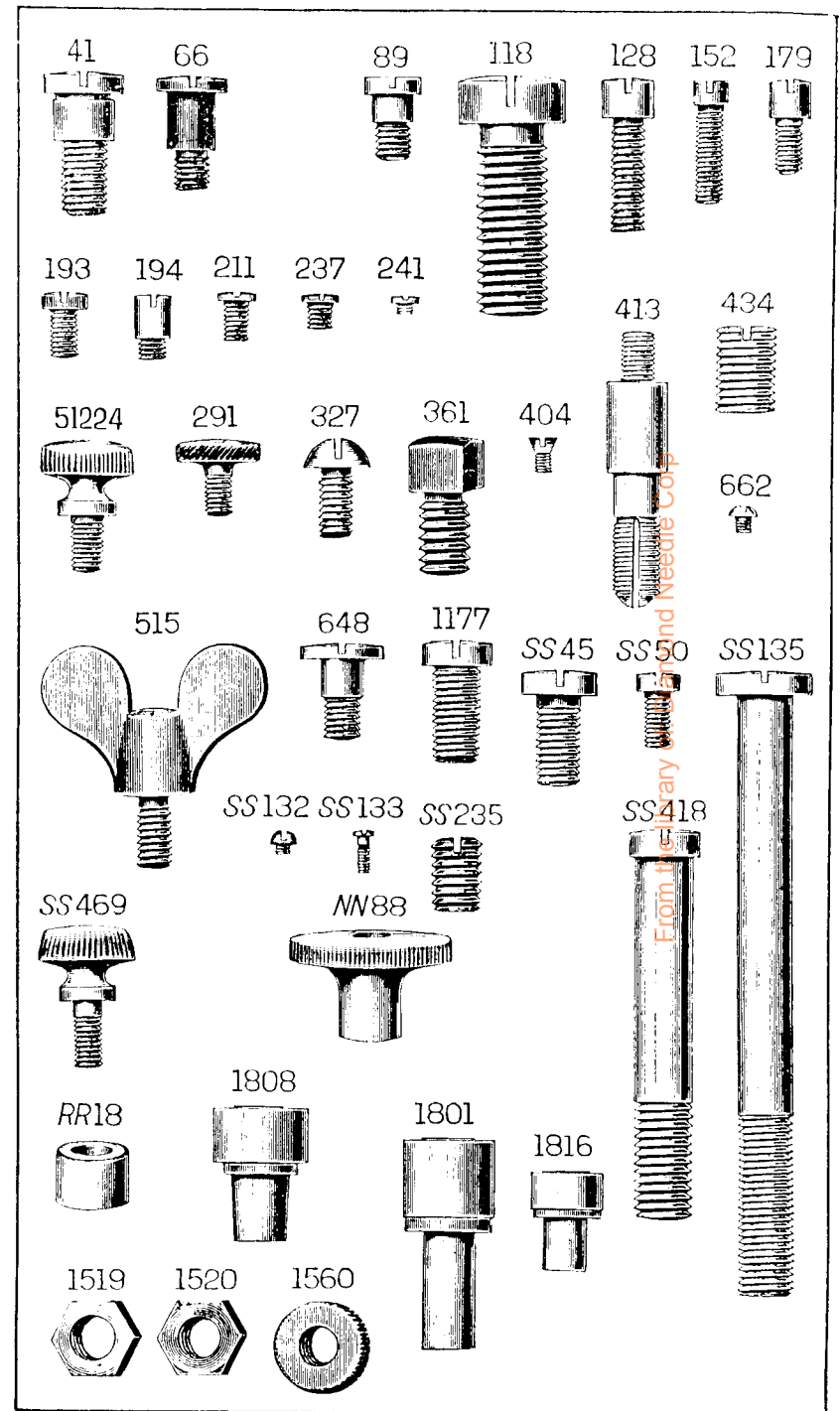
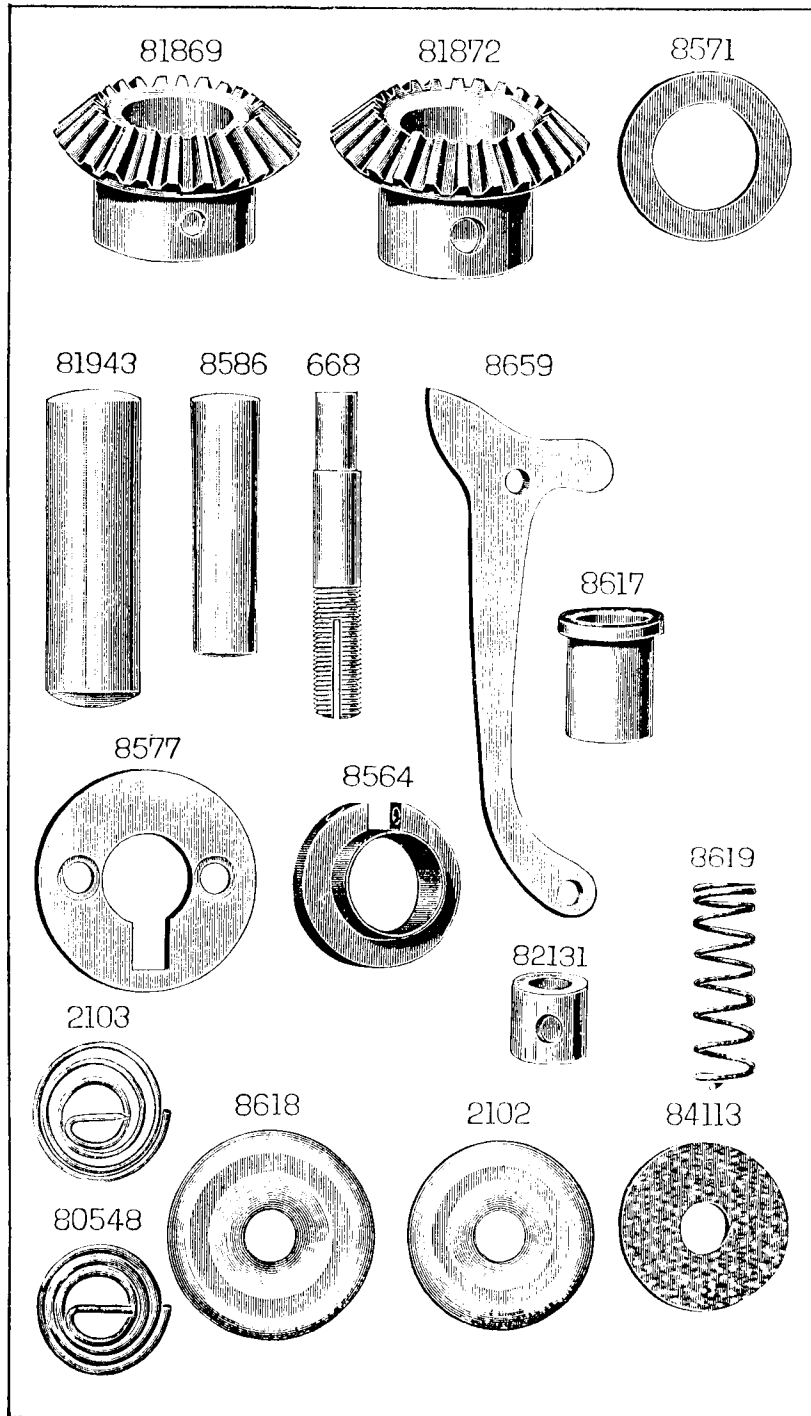

SS535

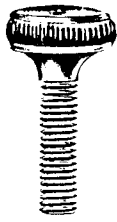

SS573



SS572

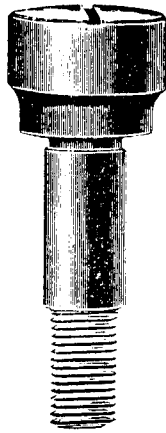

SS575

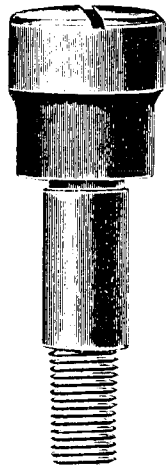

SS569

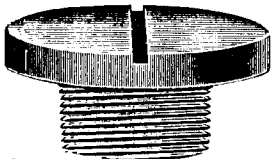

SS570



SS571



146

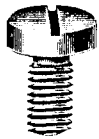

761



1423



50616

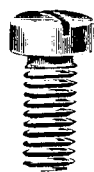

NN96

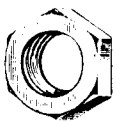

NN98



NN99



NN100



NN101

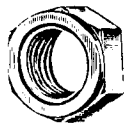

36569



25537

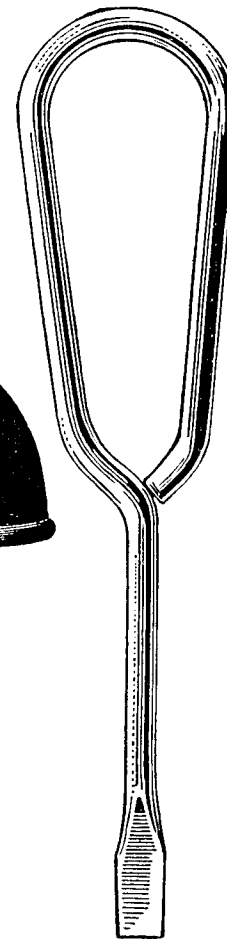

120378



From the library of: Diamond Needle Corp

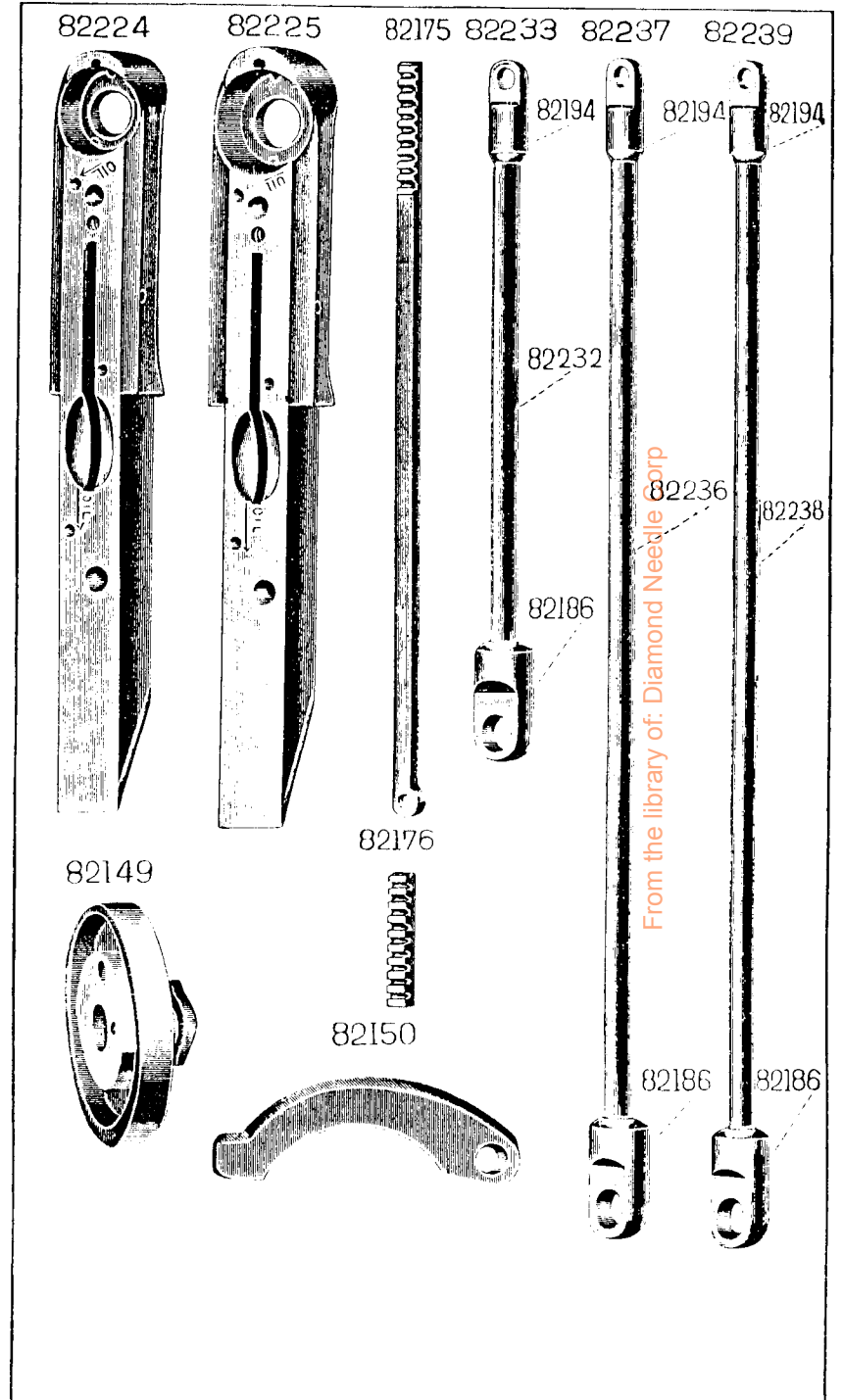
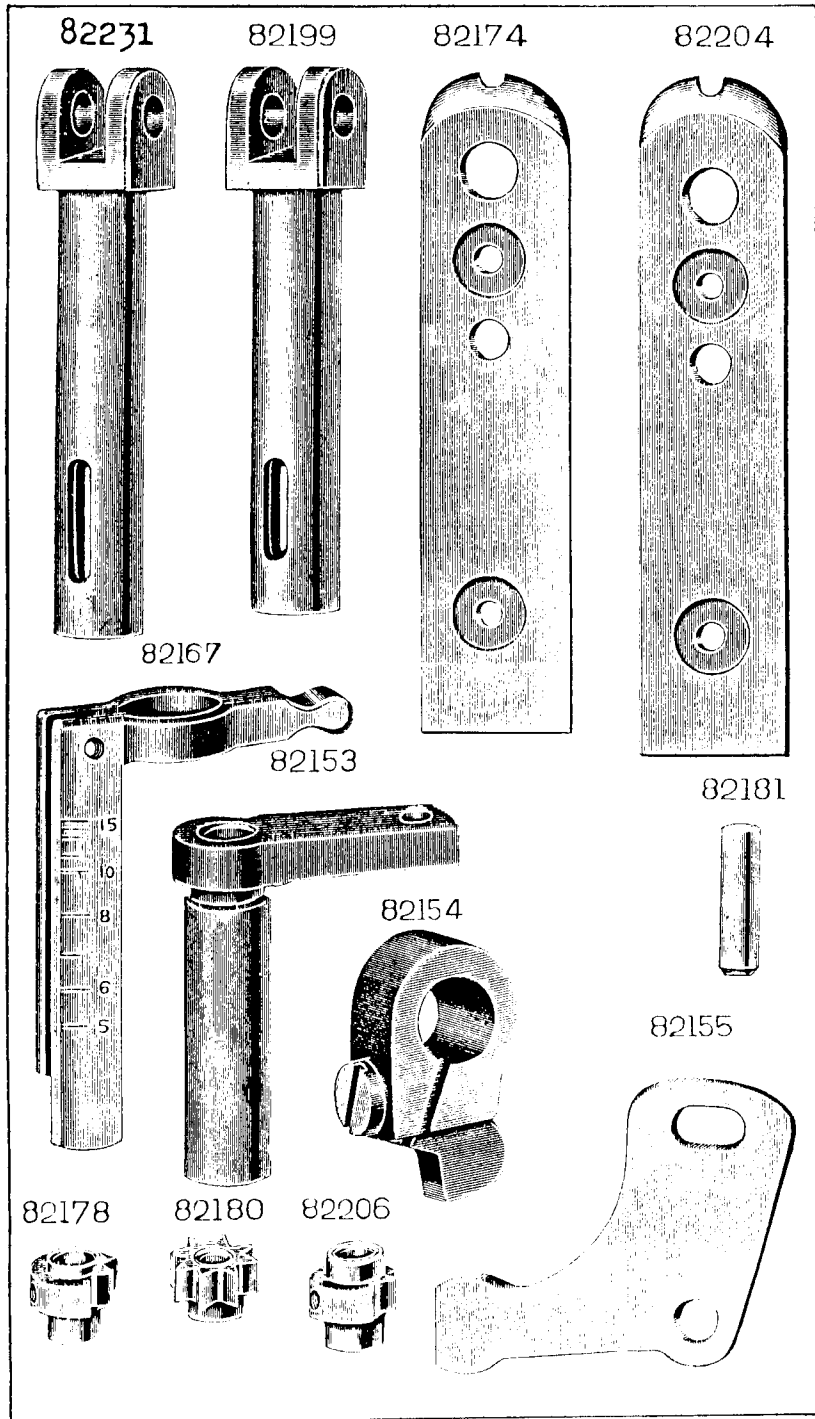



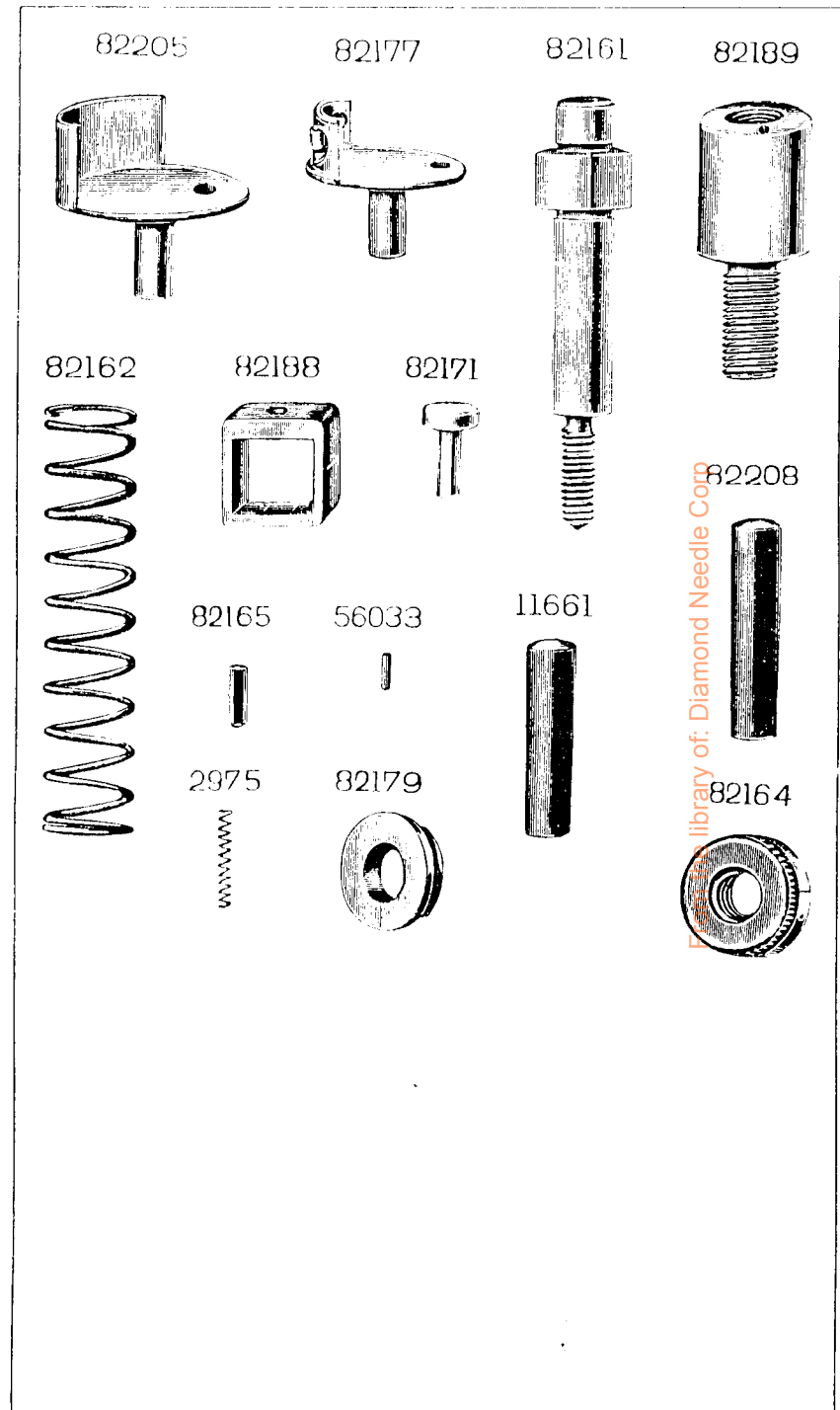
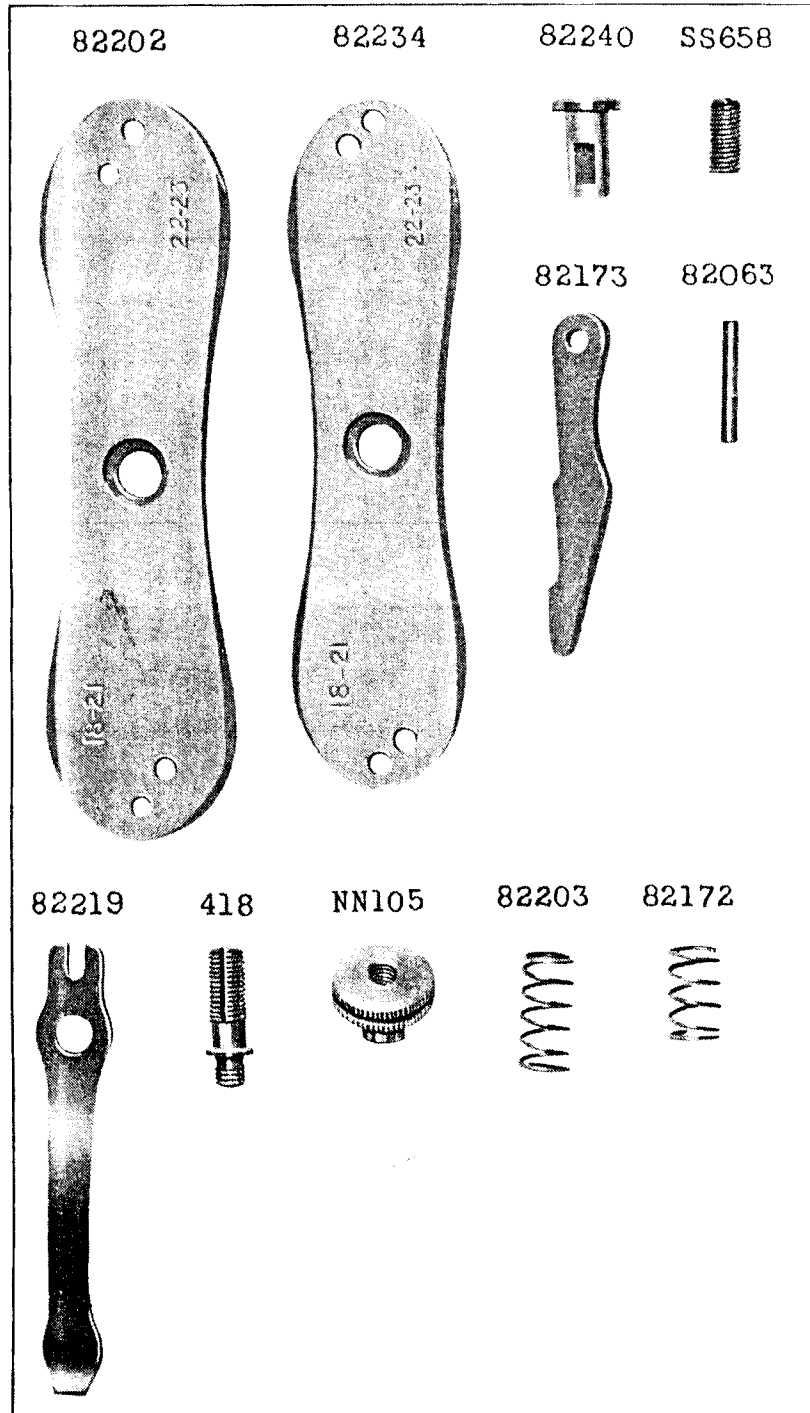

PARTS COMPLETE  
FOR  
No. 29K71 Machine

12½" from Needle to Base of Arm.

Universal Upper Feed. Oscillating Horizontal Shuttle. Stop Motion Balance Wheel. Replaceable Steel Horn. Convenient and Positive Adjustment of Presser Foot Lift. Eccentric Adjustment for Shuttle Timing. Check Lever Thread Take-up Adjustment with Indicator. Graduated Feed Motion Bell Crank to indicate the length of Stitch. Width at end of Shuttle Driving Gear Box 1", depth ⅞". Two-speed Drive, diameter of belt grooves 2⅝" and 4⅝" for Boot and Shoe Repairing, Slipper Work, etc.

No.	Plate								
*82158	---	<b>Arm</b>	with 449	...	...	...	...	...	...
118c	1998	"	Base Screw (4)	...	...	...	...	...	...
82034	---	"	Side Cover (front)	for use when machine is fitted with					
				Hand Wheel on end of Shutt					
4288	1991	"	Side Cover (back)	...	...	...	...	...	...
51224w	1998	"	"	"	Thumb Screw	...	...	...	...
8659	1997	<b>Check Lever</b>	...	...	...	...	...	...	...
82189	2570	"	"	Indicator Body	...	...	...	...	...
NN100k	1999	"	"	"	"	Lock Nut	...	...	...
82164	2570	"	"	"	Index Head	...	...	...	...
82165	2570	"	"	"	"	Locating Plunger	...	...	...
2975	2570	"	"	"	"	"	"	"	Spring
56033	2570	"	"	"	"	"	"	"	Stop Pin
8554	1995	"	"	Joint Pin	...	...	...	...	...
82219	2569	"	"	Spring	...	...	...	...	...
82216	1994	"	"	"	Steady Pin	...	...	...	...
418j	2569	"	"	"	Stud	...	...	...	...
NN105h	2569	"	"	"	"	Nut	...	...	...
SS570k	1999	"	"	Thread Take-up Adjusting Screw	...	...	...	...	...
NN99k	1999	"	"	"	"	"	"	"	Lock Nut
82166		<b>Check Lever Thread Take-up Adjusting Screw with Indicator</b> , complete, Nos. NN99k, NN100k, SS570k, 2975, 56033, 82164, 82165 and 82189	...	...	...	...	...	...	...
82007	1995	<b>Feeding Foot</b>	...	...	...	...	...	...	...
8557	1995	"	"	(narrow fork, fine)	...	...	...	...	...
8558	1995	"	"	( " " coarse)	...	...	...	...	...
8666	1995	"	"	(for waxed thread)	...	...	...	...	...
193f	1998	"	"	Screw	...	...	...	...	...

NOTE:— No. 82007 is supplied with this Machine unless otherwise specified on order.

No.	Plate						
82167	2567	<b>Feed Motion Bell Crank Lever</b> ... ..					
194c	1998	" " " " " Joint Screw (2) ... ..					
82149	2568	" " Cam Wheel with <i>RK18</i> and 81868 ... ..					
11663	1994	" " " " Pin ... ..					
82053	1990	" " Ring Slide Bar with 1816 ... ..					
1816	1998	" " " " " Roller and Stud ... ..					
8675	1991	<b>Foot Bar</b> ... ..					
8564	1997	" " Revolving Joint ... ..					
82054	1995	" " " " " Bearing ... ..					
82055	"	" " " " " 82054 with 8564 and 8571 ... ..					
8569	1995	" " " " " Hinge Pin ... ..					
82056	1995	" " " " " Slide Rod ... ..					
NN96j	1999	" " " " " Lock Nut (lower) ... ..					
NN101j	1999	" " " " " " " " (upper) ... ..					
8571	1997	" " " " " Washer ... ..					
82057	1991	<b>Foot Bar Revolving Joint</b> , complete, Nos. NN96j, NN101j, 82055 and 82056 ... ..					
82159	1987	<b>Hand Wheel</b> ... ..					
81866	1991	" " Handle (wood) ... ..					
SS135d	1998	" " " Spindle ... ..					
1519e	1998	" " " " Nut ... ..					
SS569c	1999	" " Retaining Screw ... ..					
82160	1992	" " Stop Motion Flanged Bushing with two 134c ... ..					
434c	1998	" " " " " " Binding Screw ... ..					
82161	2570	" " " " " Plunger ... ..					
82162	2570	" " " " " Spring ... ..					
761c	1999	" " " " " Stop Screw ... ..					
NN98r	1999	" " " " " Thumb Nut ... ..					
82163		<b>Hand Wheel and Stop Motion</b> , complete, Nos. NN98r, SS135d, SS569c, 761c, 1519e, 81866 and 82159 to 82162 ... ..					
82052	1990	<b>Hand Wheel Hub</b> ... ..					
SS45e	1998	" " " Screw (3) ... ..					
82008	1995	" " Shaft ... ..					
81869	1997	" " " Gear ... ..					
11663	1994	" " " " Pin ... ..					
82121		<b>Hand Wheel Hub</b> , complete, Nos. 11663, 81869, 82008 and 82052 ... ..					
<i>NOTE. When machines are fitted with Hand Wheel on Shaft, Arm Side Cover No. 82034 is supplied in place of No. 82121.</i>							
82058	1990	<b>Head of Machine</b> ... ..					
128d	1998	" Binding Screw (1) ... ..					
8573	1991	" Revolving Bush ... ..					
33534	"	" " " Friction Spring ... ..					
8575	1995	" " " " Pin ... ..					
193f	1998	" " " " Screw ... ..					

No.	Plate						
82123	1990	<b>Head Revolving Bush Handle</b> ... ..					
152f	1998	" " " " Screw (2) ... ..					
SS535w	1999	" " " Stop Thumb Screw ... ..					
8577	1997	" " " Supporting Washer ... ..					
211d	1998	" " " " " Screw (2) ... ..					
82059	1991	<b>Lifter</b> ... ..					
66f	1998	" Hinge Screw ... ..					
*82223	...	<b>Lower Arm and Bed</b> ... ..					
8582	1994	" " " " Steady Pin (2) ... ..					
82030	1991	<b>Needle Bar</b> ... ..					
81858	1994	" " Clamp with 237f ... ..					
SS50f	1998	" " " Screw ... ..					
237f	1998	" " Needle Clamping Screw ... ..					
8656	1994	" " Thread Tension Spring ... ..					
SS133d	1998	" " " " " Screw ... ..					
82031		<b>Needle Bar</b> , complete, Nos. SS50f, 8656, 81858, 82030 and two SS133d ... ..					
8661	1987	<b>Needle Bar Cam and Pulley Wheel</b> with 361c ... ..					
3012	1994	" " " " " " Pin ... ..					
361c	1998	" " " " " Set Screw ... ..					
82220	1987	<b>Needle Bar Driving Lever</b> with 1801 and 82216 ... ..					
1801	1998	" " " " Cam Roller and Stud ... ..					
8586	1997	" " " " Joint Pin ... ..					
82231	2567	" " Piston Joint ... ..					
8589	1995	<b>Needle Bar Piston Joint Pin</b> ... ..					
82235		<b>Needle Plate</b> (Fine and Medium Needle Holes) ... ..					
82234	2569	" " (Medium and Coarse Needle Holes) ... ..					
82240	2569	" " Hinge Pin ... ..					
SS658	2569	" " " " Binding Screw ... ..					
82171	2570	" " Locating Plunger ... ..					
82172	2569	" " " " Spring ... ..					
82173	2569	" " Releasing Lever ... ..					
82063	2569	" " " " Hinge Pin ... ..					
8670	1991	<b>Oil Cup</b> with 8597 and 8695 ... ..					
8695	1995	" " Oil Pad (cloth) ... ..					
327d	1998	" " Screw ... ..					
8597	1994	" " Spring ... ..					
82174	2567	<b>Pinion Cover Plate</b> ... ..					
1123j	1999	" " " Screw ... ..					
82175	2568	<b>Rack</b> (long) ... ..					
82176	2568	" (short) ... ..					

No.	Plate	
82010	1987	<b>Shaft</b> ... ..
4449	1990	" Bushing ... ..
8604	1994	<b>Shuttle Bobbin</b> ... ..
*8654	1994	" Body ... ..
662f	1998	" Tension Regulating Screw ... ..
8611	1994	" " Spring ... ..
8603	---	<b>Shuttle</b> , complete, Nos. 662f, 8604, 8611 and 8654 ... ..
<i>NOTE.— No. 8603 is supplied with this Machine unless otherwise specified on order.</i>		
81876	1994	<b>Shuttle Tension Spring</b> ... ..
81964	---	<b>Shuttle</b> , complete, Nos. 662f, 8604, 8654 and 81876 ... ..
82177	2570	<b>Shuttle Carrier</b> with 241d and 8610 ... ..
82178	2567	" " Driving Pinion ... ..
82179	2570	" " " " Bushing ... ..
SS571al	1999	" " " " Screw ... ..
82180	2567	" " Following Pinion ... ..
82181	2567	" " " " Stud ... ..
8610	1994	" " Spring ... ..
241d	1998	" " " Screw ... ..
82073	1990	<b>Shuttle Driving Cam</b> with SS235c ... ..
82122	---	" " " and Gear, Nos. 81872 and 82073 ... ..
81872	1997	" " " Gear ... ..
3012	1994	" " " " Pin ... ..
SS235c	1998	" " " " Set Screw ... ..
1808	1998	" " " Roller and Stud ... ..
*82224	2568	" " Gear Box ... ..
11661	2570	" " " " Position Pin ... ..
116j	1999	" " " " Screw (2) ... ..
82226	---	" " " " complete, Nos. SS571al, 82063, 82171 to 82181, 82221 and two 1123j
82244	---	" " " " 82224 with 82179 and 82181 (for agents only)
82245	---	" " " " 82244 with SS658 and 82240 (for agents only)
82242	---	" " " " 82226 with SS658 and 82240 ... ..
82184	1992	" " Lever with 1808 ... ..
SS572c	1999	" " " Bearing Screw ... ..
82232	2568	" " " Connecting Rod ... ..
82194	2568	" " " " End (front) ... ..
82186	2568	" " " " " (back) ... ..
8645	1995	" " " " " Pin (front) ... ..
8569	1995	" " " " " " (back) ... ..
89e	1998	" " " " " Hinge Screw ... ..
82233	2568	" " " " " complete, Nos. 8569, 8645, 82186, 82194 and 82232
SS573c	1999	" " " Eccentric Stud ... ..
1520r	1998	" " " " " Nut ... ..

No.	Plate	
8601	1994	<b>Spool Pin</b> ... ..
82188	2570	<b>Stitch Regulator</b> ... ..
8616	1995	" " " Gib ... ..
291w	1998	" " " Thumb Screw ... ..
668d	1997	<b>Tension (top) Adjusting Stud</b> ... ..
1560w	1998	" ( " ) " " Thumb Nut ... ..
8617	1997	" ( " ) Cup (release) ... ..
8618	1997	" ( " ) Disc (2) ... ..
84113	1997	" ( " ) " Washer (leather) ... ..
8619	1997	" ( " ) Spring ... ..
*413d	1998	<b>Tension (side) Adjusting Stud</b> ... ..
33892	---	" ( " ) " " 413d with 1560w ... ..
1560w	1998	" ( " ) " " Thumb Nut ... ..
2102	1997	" ( " ) Disc (2) ... ..
2103	1997	" ( " ) Spring ... ..
82116	1995	" ( " ) Thread Guide Pin ... ..
8620	1995	<b>Thread Eyelet (Head of Arm)</b> ... ..
193f	1998	" " " Screw ... ..
82151	---	<b>Vibrating Presser Lifting Lever</b> (for light work) ... ..
82150	2568	" " " " (for medium work) ... ..
82152	---	" " " " (for heavy work) ... ..
<i>NOTE.— No. 82150 is supplied with this Machine unless otherwise specified on order.</i>		
41d	1998	<b>Vibrating Presser Lifting Lever</b> Screw ... ..
82153	2567	" " " " Shaft ... ..
82155	2567	" " " " Adjusting Lever ... ..
515j	1998	" " " " " " " " Clamping Screw
8568	1994	" " " " " Adjusting Lever
648j	1998	" " " " " Clamping Screw Rivet
82154	2567	" " " " " Adjusting Lever
1177c	1998	" " " " " Lever with 1177c ... ..
RR18	1998	" " " " " Clamping Screw
81868	1994	" " " Roller ... ..
82083	1991	" " " Pin ... ..
82129	1991	" " " Spring (light) ... ..
<i>NOTE.— No. 82129 is supplied with this Machine unless otherwise specified on order.</i>		
82130	1991	" " " Spring (heavy) ... ..
82130	1991	<b>Vibrating Presser Spring Bar</b> ... ..
NN88w	1998	" " " " Adjusting Nut ... ..
82131	1997	" " " " Collar ... ..
179e	1998	" " " " Screw ... ..

**PARTS COMPLETE**  
FOR  
**No. 29K72 Machine**

17½ ins. from Needle to Base of Arm.

**Universal Upper Feed. Oscillating Horizontal Shuttle. Stop Motion Balance Wheel. Replaceable Steel Horn. Convenient and Positive Adjustment of Presser Foot Lift. Eccentric Adjustment for Shuttle Timing. Check Lever Thread Take-up Adjustment with Indicator. Graduated Feed Motion Bell Crank to indicate the length of Stitch. Width at end of Shuttle Driving Gear Box 1  $\frac{5}{32}$ " , depth 1  $\frac{1}{16}$ ". Two-speed Drive, diameter of belt grooves 3  $\frac{1}{2}$ " and 5  $\frac{1}{2}$ ". Large Shuttle. For Waxed Thread. For Boot and Shoe Repairing, Slipper Work, etc.**

No.	Plate	
*82195	-	<b>Arm with 4449</b> ... ..
118e	1998	" Base Screw (4)
82034	-	" Side Cover (front) for use when machine is fitted with Hand Wheel on end of Shaft
4288	1991	" Side Cover (back)
51224w	1998	" " " Thumb Screw
8659	1997	<b>Check Lever</b> ... ..
82189	2570	" " Indicator Body
NN100k	1999	" " " " Lock Nut
82164	2570	" " " " Index Head
82165	2570	" " " " " Locating Plunger
2975	2570	" " " " " " " " Spring
56033	2570	" " " " " " " " Stop Pin
8554	1995	" " " " " " " " Joint Pin
82219	2569	" " " " " " " " Spring
82216	1994	" " " " " " " " Steady Pin
418j	2569	" " " " " " " " Stud
NN105b	2569	" " " " " " " " Nut
SS570k	1999	" " " " " " " " Thread Take up Adjusting Screw
NN99k	1999	" " " " " " " " " Lock Nut
82166	-	<b>Check Lever Thread Take-up Adjusting Screw with Indicator</b> , complete, Nos. NN99k, NN100k, SS570k, 2975, 56033, 82164, 82165 and 82189
82007	1995	<b>Feeding Foot</b> ... ..
8557	1995	" " (narrow fork, fine)
8558	1995	" " ( " " coarse)
8666	1995	" " (for waxed thread)
193f	1998	" " " " Screw

*NOTE. -No. 8666 is supplied with this Machine unless otherwise specified on order.*

No.	Plate	
82167	2567	<b>Feed Motion Bell Crank Lever</b> ... ..
194e	1998	" " " " " " " " Joint Screw (2)
82149	2568	" " " " " " " " Cam Wheel with R/18 and 81868
11663	1994	" " " " " " " " Pin
82053	1990	" " " " " " " " Ring Slide Bar with 1816
1816	1998	" " " " " " " " Roller and Stud
8675	1994	<b>Foot Bar</b> ... ..
8564	1997	" " " " " " " " Revolving Joint
82054	1995	" " " " " " " " Bearing
82055	-	" " " " " " " " " 82054 with 8564 and 8571
8569	1995	" " " " " " " " Hinge Pin
82056	1995	" " " " " " " " Slide Rod
NN96j	1999	" " " " " " " " " Lock Nut (lower)
NN101j	1999	" " " " " " " " " " " " " " " (upper)
8571	1997	" " " " " " " " " " " " " " " Washer
82057	1991	<b>Foot Bar Revolving Joint</b> , complete, Nos. NN96j, NN101j, 82055 and 82056
82159	1987	<b>Hand Wheel</b> ... ..
81866	1994	" " " " " " " " Handle (wood)
SS135d	1998	" " " " " " " " Spindle
1519e	1998	" " " " " " " " " Nut
SS569c	1999	" " " " " " " " Retaining Screw
82160	1992	" " " " " " " " " Stop Motion Flanged Bushing with two 43c
434c	1998	" " " " " " " " " " " " " " " Binding Screw
82161	2570	" " " " " " " " " " " " " " " Plunger
82162	2570	" " " " " " " " " " " " " " " Spring
761c	1999	" " " " " " " " " " " " " " " Stop Screw
NN98r	1999	" " " " " " " " " " " " " " " Thumb Nut
82163	-	<b>Hand Wheel and Stop Motion</b> , complete, Nos. NN98r, SS135d, SS569c, 761c, 1519e, 81866 and 82159 to 82162
82052	1990	<b>Hand Wheel Hub</b> ... ..
SS15e	1998	" " " " " " " " " " " " " " " Screw (3)
82008	1995	" " " " " " " " " " " " " " " Shaft
81869	1997	" " " " " " " " " " " " " " " Gear
11663	1994	" " " " " " " " " " " " " " " Pin
82121	-	<b>Hand Wheel Hub</b> , complete, Nos. 11663, 81869, 82008 and 82052

*NOTE. When machines are fitted with Hand Wheel on Shaft, Arm Side Cover No. 82034 is supplied in place of No. 82121.*

No.	Plate	
82058	1990	<b>Head of Machine</b> ... ..
128d	1998	" " " " " " " " " " " " " " " Binding Screw (4)
8573	1991	" " " " " " " " " " " " " " " Revolving Bush
33534	-	" " " " " " " " " " " " " " " Friction Spring
8575	1995	" " " " " " " " " " " " " " " Pin
193f	1998	" " " " " " " " " " " " " " " Screw

No.	Plate						
82123	1990	<b>Head</b>	Revolving Bush Handle	...	...	...	...
152f	1998	"	" " " " Screw (2)	...	...	...	...
SS535w	1999	"	" " " Stop Thumb Screw	...	...	...	...
8577	1997	"	" " " Supporting Washer	...	...	...	...
211d	1998	"	" " " " " Screw (2)	...	...	...	...
82059	1991	<b>Lifter</b>	...	...	...	...	...
66f	1998	"	Hinge Screw	...	...	...	...
*82200	---	<b>Lower Arm and Bed</b>	...	...	...	...	...
8582	1994	"	" " " " Steady Pin (2)	...	...	...	...
82212	1992	<b>Needle Bar</b>	...	...	...	...	...
81888	1994	"	" " Clamp with 237f	...	...	...	...
SS50f	1998	"	" " " Screw	...	...	...	...
237f	1998	"	" " Needle Clamping Screw	...	...	...	...
8656	1994	"	" " Thread Tension Spring	...	...	...	...
SS133d	1998	"	" " " " " Screw	...	...	...	...
82213	---	<b>Needle Bar</b> , complete, Nos. SS50f, 8656, 81888, 82212 and two SS133d	...	...	...	...	...
81941	1987	<b>Needle Bar Cam and Pulley Wheel</b> with 361c	...	...	...	...	...
3012	1994	"	" " " " " " Pin	...	...	...	...
361c	1998	"	" " " " " " Set Screw	...	...	...	...
82241	1987	<b>Needle Bar Driving Lever</b> with 1801 and 82216	...	...	...	...	...
1801	1998	"	" " " " Cam Roller and Stud	...	...	...	...
81943	1997	"	" " " " Joint Pin	...	...	...	...
82199	2567	"	" " Piston Joint	...	...	...	...
8589	1995	<b>Needle Bar</b> Piston Joint Pin	...	...	...	...	...
82201	---	<b>Needle Plate</b> (Fine and Medium Needle Holes)	...	...	...	...	...
82202	2569	"	" " (Medium and Coarse Needle Holes)	...	...	...	...
82240	2569	"	" " Hinge Pin	...	...	...	...
SS658	2569	"	" " " " Binding Screw	...	...	...	...
82171	2570	"	" " Locating Plunger	...	...	...	...
82203	2569	"	" " " " Spring	...	...	...	...
82173	2569	"	" " Releasing Lever	...	...	...	...
82063	2569	"	" " " " Hinge Pin	...	...	...	...
8670	1991	<b>Oil Cup</b> with 8597 and 8695	...	...	...	...	...
8695	1995	"	" " Oil Pad (cloth)	...	...	...	...
327d	1998	"	" " Screw	...	...	...	...
8597	1994	"	" " Spring	...	...	...	...
82204	2567	<b>Pinion Cover Plate</b>	...	...	...	...	...
1423j	1999	"	" " " Screw	...	...	...	...
82175	2568	<b>Rack</b> (long)	...	...	...	...	...
82176	2568	"	" (short)	...	...	...	...

No.	Plate						
82011	1987	<b>Shaft</b>	...	...	...	...	...
4449	1990	"	Bushing	...	...	...	...
82552	1994	<b>Shuttle Bobbin</b>	...	...	...	...	...
7868	1994	"	" " Retaining Spring	...	...	...	...
SS133d	1998	"	" " " " Screw	...	...	...	...
*81993	1994	"	" Body	...	...	...	...
SS132d	1998	"	" Tension Regulating Screw	...	...	...	...
81994	1994	"	" " Spring	...	...	...	...
81951	1994	"	" Thread Pull-off	...	...	...	...
404d	1998	"	" " " Screw	...	...	...	...
81952	---	<b>Shuttle</b> , complete, Nos. SS132d, SS133d, 404d, 7868, 81951, 81993, 81994 and 82552	...	...	...	...	...
82205	2570	<b>Shuttle Carrier</b>	...	...	...	...	...
82206	2567	"	" " Driving Pinion	...	...	...	...
82179	2570	"	" " " " Bushing	...	...	...	...
SS571al	1999	"	" " " " Screw	...	...	...	...
82180	2567	"	" " Following Pinion	...	...	...	...
82181	2567	"	" " " " Stud	...	...	...	...
82073	1990	<b>Shuttle Driving Cam</b> with SS235c	...	...	...	...	...
82122	---	"	" " " and Gear, Nos. 81872 and 82073	...	...	...	...
81872	1997	"	" " " Gear	...	...	...	...
3012	1994	"	" " " " Pin	...	...	...	...
SS235c	1998	"	" " " " Set Screw	...	...	...	...
1808	1998	"	" " " Roller and Stud	...	...	...	...
*82225	2568	"	" " Gear Box	...	...	...	...
82208	2570	"	" " " Position Pin	...	...	...	...
116j	1999	"	" " " " Screw (2)	...	...	...	...
82227	---	"	" " " " complete, Nos. SS571al, 82063, 82171, 82173, 82175, 82176, 82179 to 82181, 82203 to 82206, 82225 and two 1123j	...	...	...	...
82246	---	"	" " Gear Box 82225 with 82179 and 82181 (for agents only)	...	...	...	...
82247	---	"	" " " " 82246 with SS658 and 82240 (for agents only)	...	...	...	...
82243	---	"	" " " " 82227 with SS658 and 82240	...	...	...	...
82184	1992	"	" " Lever with 1808	...	...	...	...
SS575c	1999	"	" " " Bearing Screw	...	...	...	...
82236	2568	"	" " " Connecting Rod	...	...	...	...
82194	2568	"	" " " " End (front)	...	...	...	...
82186	2568	"	" " " " " (back)	...	...	...	...
8645	1995	"	" " " " " Pin (front)	...	...	...	...
8569	1995	"	" " " " " (back)	...	...	...	...
89e	1998	"	" " " " Hinge Screw	...	...	...	...
82237	2568	"	" " " " complete, Nos. 8569, 8645, 82186, 82194 and 82236	...	...	...	...
SS573c	1999	"	" " " Eccentric Stud	...	...	...	...
1520r	1998	"	" " " " Nut	...	...	...	...

No.	Plate							
8601	1994	<b>Spool Pin</b>	...	...	...	...	...	...
82188	2570	<b>Stitch Regulator</b>	...	...	...	...	...	...
8616	1995	" "	Gib	...	...	...	...	...
291w	1998	" "	Thumb Screw	...	...	...	...	...
668d	1997	<b>Tension (top) Adjusting Stud</b>	...	...	...	...	...	...
1560w	1998	" ( " )	" "	Thumb Nut	...	...	...	...
8617	1997	" ( " )	Cup (release)	...	...	...	...	...
8618	1997	" ( " )	Disc (2)	...	...	...	...	...
84113	1997	" ( " )	Washer (leather)	...	...	...	...	...
8619	1997	" ( " )	Spring	...	...	...	...	...
*413d	1998	<b>Tension (side) Adjusting Stud</b>	...	...	...	...	...	...
33892	—	" ( " )	" "	413d with 1560w	...	...	...	...
1560w	1998	" ( " )	" "	Thumb Nut	...	...	...	...
2102	1997	" ( " )	Disc (2)	...	...	...	...	...
80548	1997	" ( " )	Spring	...	...	...	...	...
82116	1995	" ( " )	Thread Guide Pin	...	...	...	...	...
8620	1995	<b>Thread Eyelet (Head of Arm)</b>	...	...	...	...	...	...
193f	1998	" "	Screw	...	...	...	...	...
82151		<b>Vibrating Presser Lifting Lever</b> (for light work)	...	...	...	...	...	...
82150	2568	" "	" "	(for medium work)	...	...	...	...
82152		" "	" "	(for heavy work)	...	...	...	...

NOTE. No. 82150 is supplied with this Machine unless otherwise specified on order.

41d	1998	<b>Vibrating Presser Lifting Lever</b>	Screw	...	...	...	...	...
82153	2567	" "	" "	Shaft	...	...	...	...
82155	2567	" "	" "	" "	Adjusting Lever	...	...	...
515j	1998	" "	" "	" "	" "	Clamping Screw	...	...
8568	1994	" "	" "	" "	Adjusting Lever	...	...	...
648j	1998	" "	" "	" "	Adjusting Lever	Clamping Screw	...	...
82151	2567	" "	" "	" "	Lever with 4177c	Hinge Screw	...	...
1177c	1998	" "	" "	" "	" "	Clamping Screw	...	...
RR18	1998	" "	" "	Roller	...	...	...	...
81868	1994	" "	" "	Pin	...	...	...	...
82083	1991	" "	" "	Spring (light)	...	...	...	...
82129	1991	" "	" "	(heavy)	...	...	...	...

NOTE. No. 82129 is supplied with this Machine unless otherwise specified on order.

82130	1991	<b>Vibrating Presser Spring Bar</b>	...	...	...	...	...	...
NA88w	1998	" "	" "	Adjusting Nut	...	...	...	...
82131	1997	" "	" "	Collar	...	...	...	...
179e	1998	" "	" "	" "	Screw	...	...	...

## PARTS SPECIAL TO No. 29K73 Machine

17½ ins. from Needle to Base of Arm.

Universal Upper Feed. Oscillating Horizontal Shuttle. Stop Motion Balance Wheel. Replacable Steel Horn. Convenient and Positive Adjustment of Presser Foot Lift. Eccentric Adjustment for Shuttle Timing. Check Lever Thread Take-up Adjustment with Indicator. Graduated Feed Motion Bell Crank to indicate the length of Stitch. Width at end of Shuttle Driving Gear Box 1", depth ¾". Two-speed Drive, diameter of belt grooves 3¼" and 5¼". For Waxed Thread. For Boot and Shoe Repairing, Slipper Work, etc.

This machine is the same as 29K71 with the following exceptions:

No.	Plate							
*82195		<b>Arm with 4149</b>	...	...	...	...	...	...
*82196		<b>Lower Arm and Bed</b>	...	...	...	...	...	...
81941	1987	<b>Needle Bar Cam and Pulley Wheel</b> with 361e	...	...	...	...	...	...
82241	1987	" "	Driving Lever with 180f and 82246	...	...	...	...	...
81943	1997	" "	" "	Joint Pin	...	...	...	...
82199	2567	" "	" "	Piston Joint	...	...	...	...
82235		<b>Needle Plate</b> (fine and medium needle holes), for E'port	...	...	...	...	...	...
82234	2569	" "	" "	(medium and course needle holes), for E'port	...	...	...	...
82011	1987	<b>Shaft</b>	...	...	...	...	...	...
SS375c	1999	<b>Shuttle Driving Lever Bearing Screw</b>	...	...	...	...	...	...
82238	2568	" "	" "	Connecting Rod	...	...	...	...
82239	2568	" "	" "	" "	complete, Nos. 8569, 8615, 82186, 82194 and 82238	...	...	...

From the library of: Diamond Needle Co.

## ACCESSORIES

### ACCESSORIES supplied with 29K71 and 29K73 Machines

No.	Plate		...	...	...	...	...
		Instruction Book	...	...	...	...	...
50616c	1999	Machine Screw (4) (for fastening Machine to Stand)	...	...	...	...	...
SS418c	1998	" " (4) (for fastening Machine to Power Table)	...	...	...	...	...
82833	1994	" " Washer (4) for SS418c	...	...	...	...	...
29 × 4		Needles (2 each, sizes 19, 21 and 22)	...	...	...	...	...
8590	1991	Needle Bar Threading Wire	...	...	...	...	...
36569	2499	Oiler	...	...	...	...	...
25537	2499	Screw Driver (Machine)	...	...	...	...	...
120378	2499	" " (Shuttle Tension)	...	...	...	...	...
8604	1994	Shuttle Bobbin (2)	...	...	...	...	...

### ACCESSORIES supplied with 29K72 Machine

These are the same as for 29K71 Machine with the following exception:

No.	Plate		...	...	...	...	...
82552	1994	Shuttle Bobbin (2)	...	...	...	...	...



## BOBBIN WINDERS

### BOBBIN WINDER for 29K71 and 29K73 Machines

No.	Plate							
8684	1484	Eccentric	...	...	...	...	...	...
SS469w	1998	" Thumb Screw	...	...	...	...	...	...
82086	1484	Frame	...	...	...	...	...	...
128d	1998	" Screw	...	...	...	...	...	...
8651	1484	Spindle	...	...	...	...	...	...
81965	---	" 8651 with 8371	...	...	...	...	...	...
8371	1484	" Pulley	...	...	...	...	...	...
2460	1484	" " Rubber Ring	...	...	...	...	...	...
82087	1484	Bobbin Winder, complete, Nos. 128d, SS469w, 2460, 8684, 81965 and 82086	...	...	...	...	...	...

### BOBBIN WINDER for 29K72 Machine

No.	Plate							
8684	1484	Eccentric	...	...	...	...	...	...
SS469w	1998	" Thumb Screw	...	...	...	...	...	...
82086	1484	Frame	...	...	...	...	...	...
128d	1998	" Screw	...	...	...	...	...	...
82088	1484	Spindle	...	...	...	...	...	...
82089	---	" 82088 with 8371	...	...	...	...	...	...
8371	1484	" Pulley	...	...	...	...	...	...
2460	1484	" " Rubber Ring	...	...	...	...	...	...
82090	1484	Bobbin Winder, complete, Nos. 128d, SS469w, 2460, 8684, 82086 and 82089	...	...	...	...	...	...

## Machine Bases for Power Tables

No.	Plate							
82214	---	Machine Base, for 29K71 Machine	...	...	...	...	...	...
82113	---	" " " 29K72 and 29K73 Machines	...	...	...	...	...	...
50616e	1999	" " Screw (for fastening Base to Machine) (4)	...	...	...	...	...	...
---	---	" " Screw (wood) 1" No. 12 (for fastening Base to Power Table) (4)	...	...	...	...	...	...

*These bases are only supplied when specified on order and are charged extra.*